

DO NOT SCALE FROM DRAWING. IF IN DOUBT: ASK

UNLESS OTHERWISE SPECIFIED, ALL DIMENSIONS ARE IN MILLIMETRES

BEWARE OF 100mm MEASURING ERROR

TANK DATA	
TANK CONTENTS:	DIESEL
DESIGNED TO:	UL142,ULC S601
BUILT TO:	UL142,ULC S601
PLATE THICKNESS:	6mm
GROSS VOLUME:	82,959L
HYD. TEST PRESSURE:	GROSS LEVEL+150mm
SAFE FILL LEVEL:	76,000L
N.D.T	Refer fabrication&assembly plan
TOTAL MASS:	14,506KG

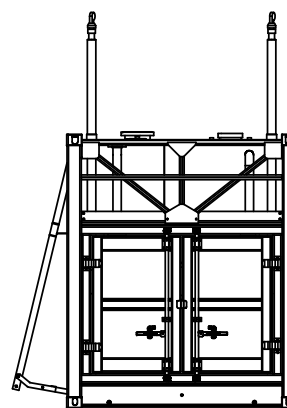
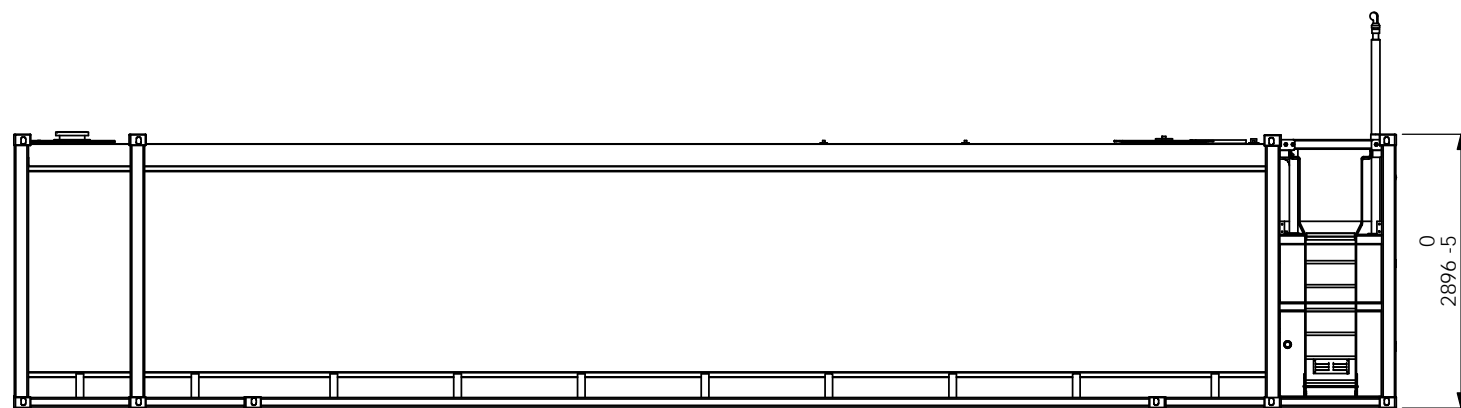
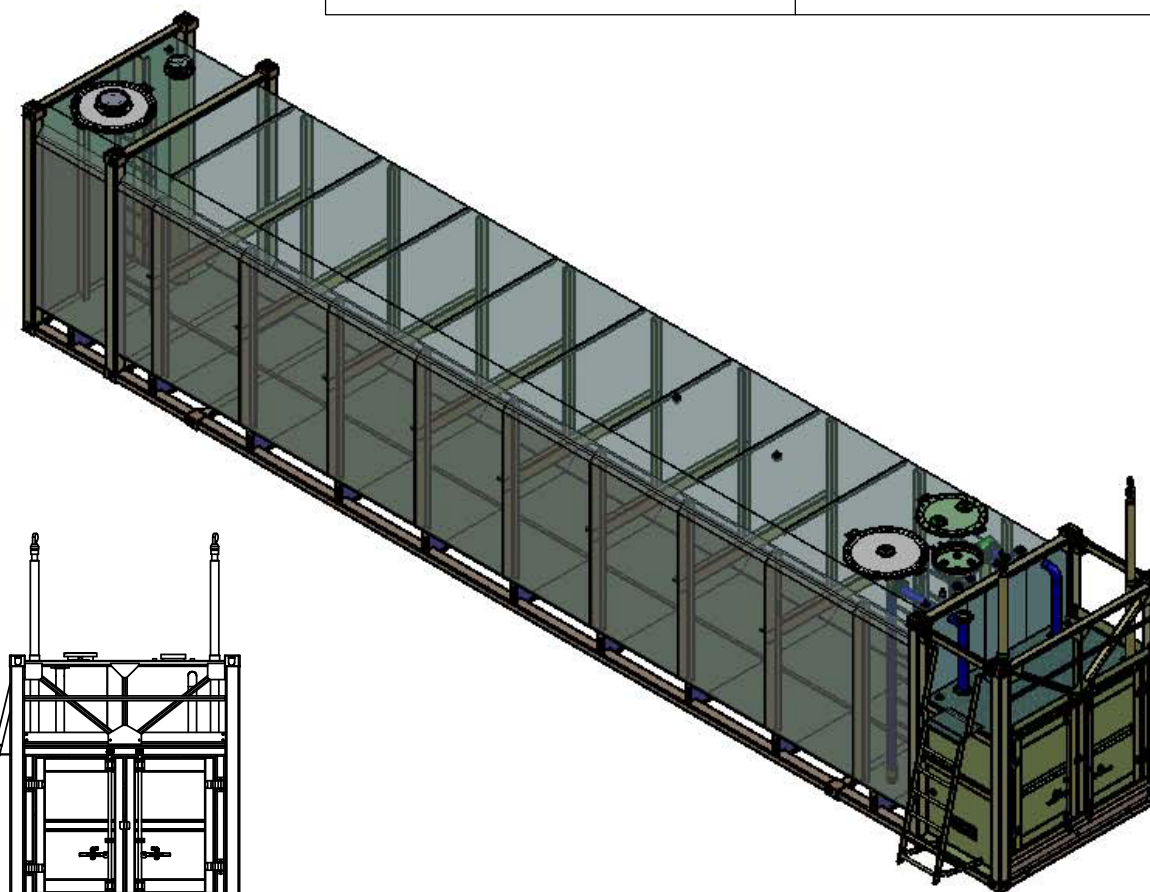
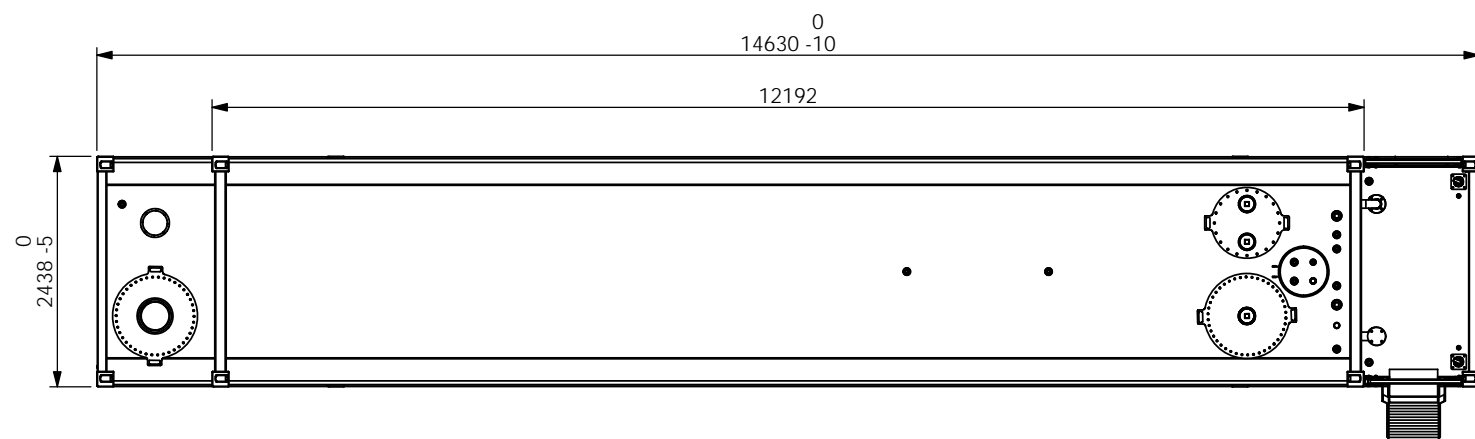

THIRD ANGLE PROJECTION	
NAME	DATE
DRAWN	2016/7/19
CHK'D	
APP'VD	



TOLERANCE U.N.O.	MATERIAL:
0 = -1.0	
0.0 = -0.4	
0.00 = -0.1	WEIGHT: 14532.90 Kg

DWG NO. / PART NO.		JOB NO.	
CLIENT: CON-80 SELF BUNDED TANK			
TITLE:			SHEET SIZE A3
SCALE: N.T.S.		SHEET 1 OF 1	
			REVISION 01

DO NOT SCALE - IF IN DOUBT ASK

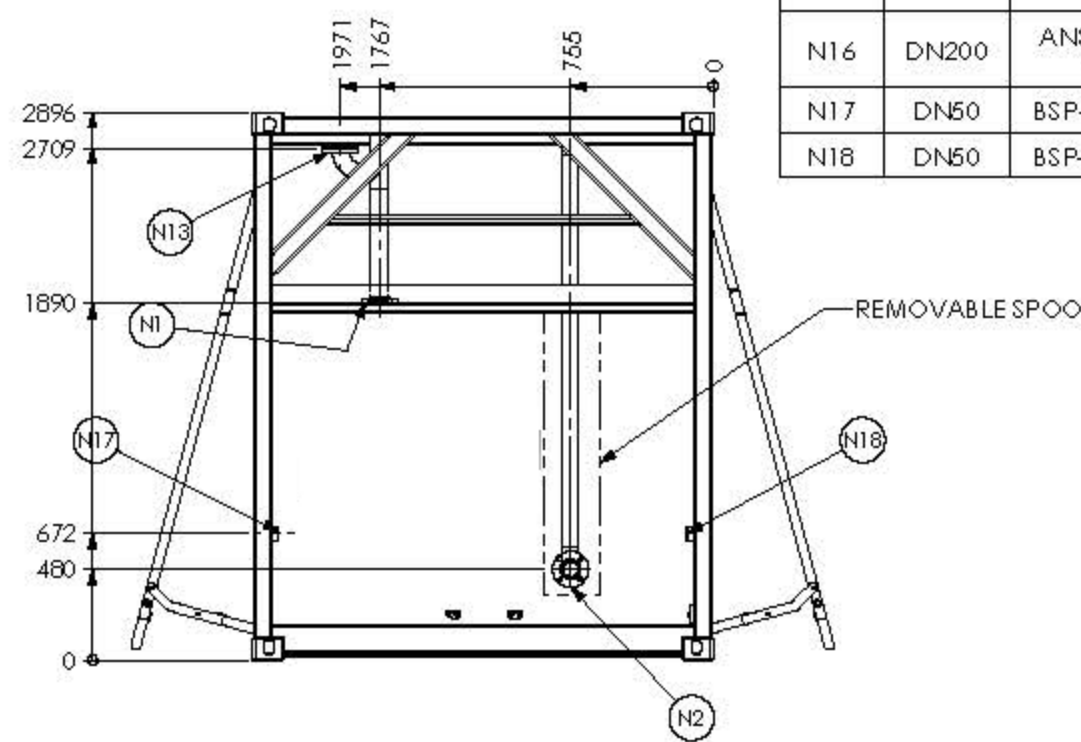
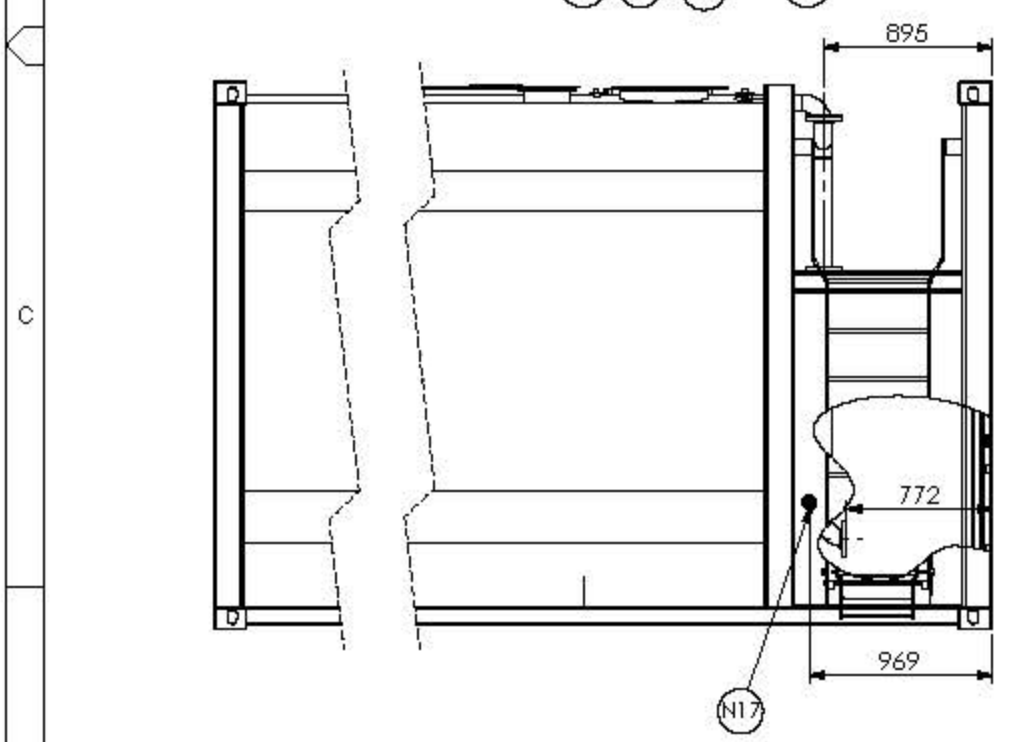
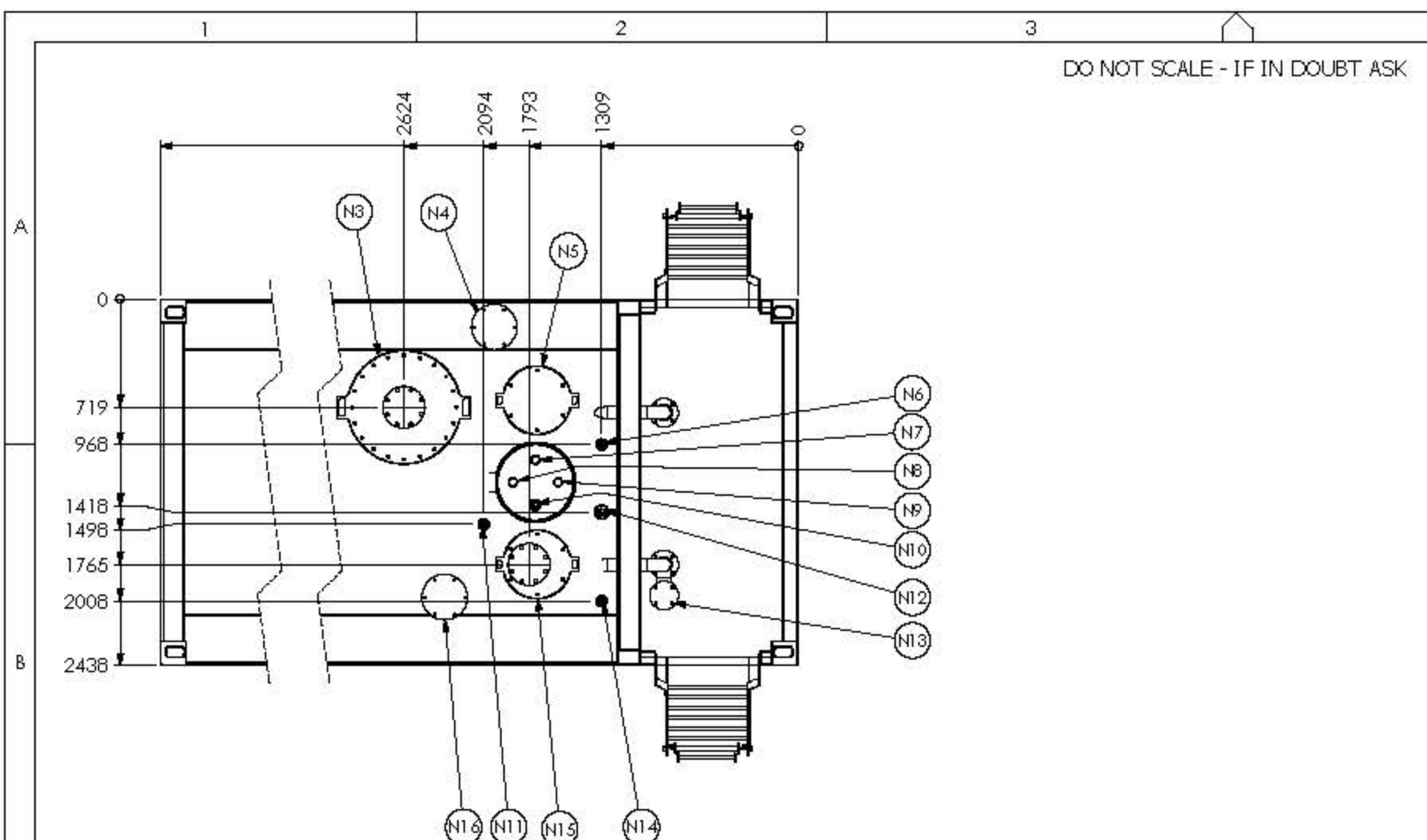

NOZZLE NO.	SIZE	CONNECTION TYPE	DESCRIPTION
N1	DN80	ANSI CLASS 150 FLANGE	SUCTION C/W DN80 PIPE 110mm FROM FLOOR & ANTI-SYPHON VALVE
N2	DN80	ANSI CLASS 150 FLANGE	FILL PIPE C/W DN80 PIPE W/ ELBOW 44mm FROM FLOOR & OVERFILL PROTECTION VALVE AND SPOOL
N3	600	MANWAY	600mm MANWAY C/W DN150 ANSI CLASS 150 FLANGE FOR SUB PUMP
N4	DN200	ANSI CLASS 150 FLANGE	INTERSTITIAL SPACE EMERGENCY VENT
N5	350	HATCH	350mm INSPECTION HATCH
N6	DN50	BSP-F x 50 LONG	OVERFILL WARNING ALARM
N7	DN50	BSP-M x 35 LONG	PRIMARY TANK DIP C/W DN50 PIPE 25mm HIGH OPENING FROM DIP STRIKE
N8	DN50	BSP-M x 35 LONG	INTERSTITIAL SPACE DIP C/W DN50 PIPE THROUGH INTERNAL FLOOR
N9	DN50	BSP-M x 35 LONG	SUCTION SPEAR, DN50 PIPE 3mm FROM MAIN FLOOR INTO DISHED SUMP C/W THREADED CAP
N10	DN50	BSP-F x 50 LONG	SPARE
N11	DN50	BSP-F x 50 LONG	SPARE / GAUGE / VENT
N12	DN80	BSP-F x 75 LONG	SPARE / GAUGE / VENT
N13	DN80	ANSI CLASS 150 FLANGE	SUCTION PRIMING PORT / SUBMERSIBLE PUMP CONNECTION
N14	DN50	BSP-F x 50 LONG	SPARE / GAUGE
N15	350	HATCH	350mm INSPECTION HATCH C/W DN150 ANSI CLASS 150 FLANGE FOR SUB PUMP
N16	DN200	ANSI CLASS 150 FLANGE	PRIMARY TANK EMERGENCY VENT
N17	DN50	BSP-F x 50 LONG	SPARE (INTO PUMP BAY) / EXTERNAL ELECTRICALS
N18	DN50	BSP-F x 50 LONG	SPARE (INTO PUMP BAY) / EXTERNAL ELECTRICALS

BSP-F: BSP FEMALE THREAD
BSP-M: BSP MALE THREAD

Rev. No.	ZONE	Revised	Date	By	Checked
C	-	INFORMATION	02.11.15	ND	
B	-	INFORMATION	23.10.15	ND	
A	-	ISSUED FOR REVIEW	20.10.15	GS	

DO NOT SCALE
DIMENSIONS ARE IN MILLIMETRES
UNLESS OTHERWISE NOTED

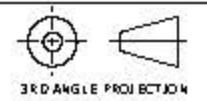

Client:
Title:
GO 80,000L Self Bunded Tank

Drawn	KG	Checked	
Date:	26.10.15	Approved	
Drawing number:			
Sheet No: 2 of 2			
Scale:	NTS	Rev:	C
		A3	