

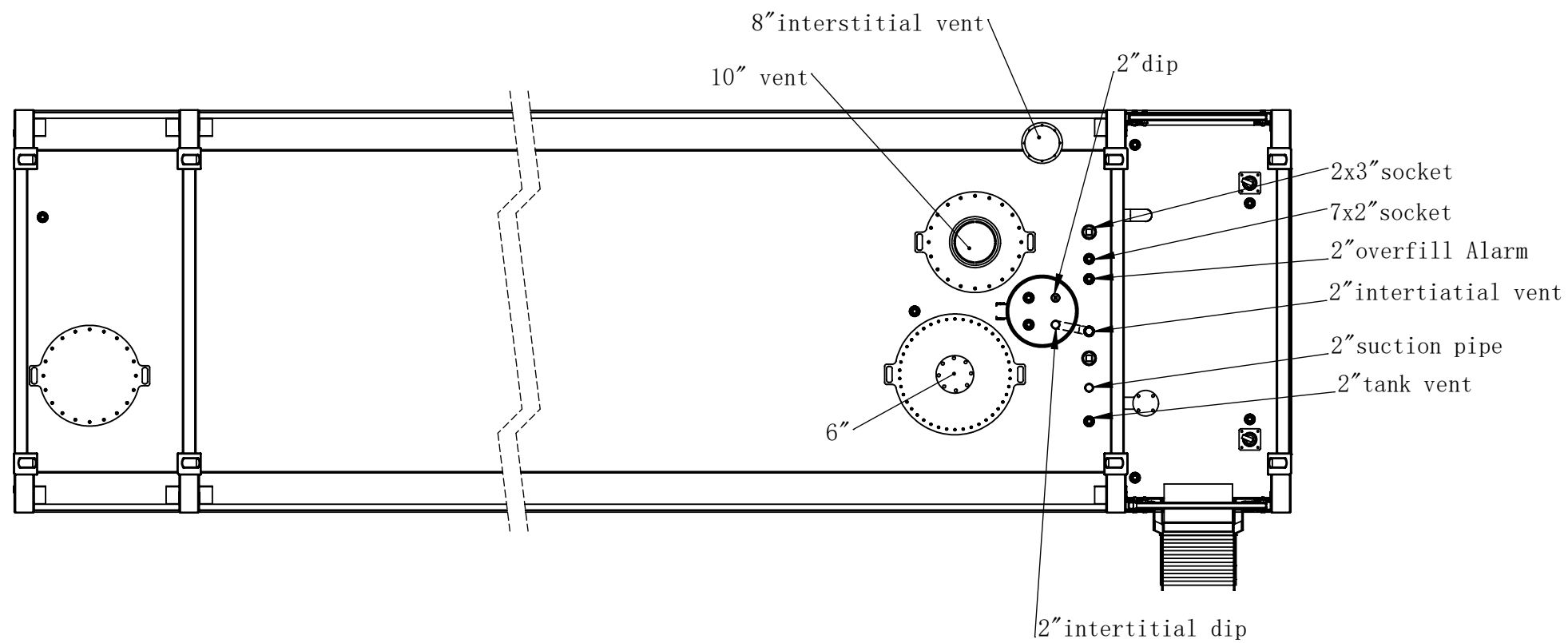

TANK DATA	
CONTENT	DIESEL
DESIGNED TO	AS1940
BUILT TO	AS1692, CAT. 3
CORROSION ALLOW	0mm
GROSS VOLUME	112500L
HYD. TEST PRESSURE	21KPa
SAFE FILL LEVEL	106500L
N. D. T.	Refer fabrication&assembly plan
TOTAL MASS	19148. 83Kg (EMPTY)

07					
06					
05					
04					
03					
02					
01					
REV:	DATE:	REVISION:	DRAWN:	CHECKED:	APPROVED:

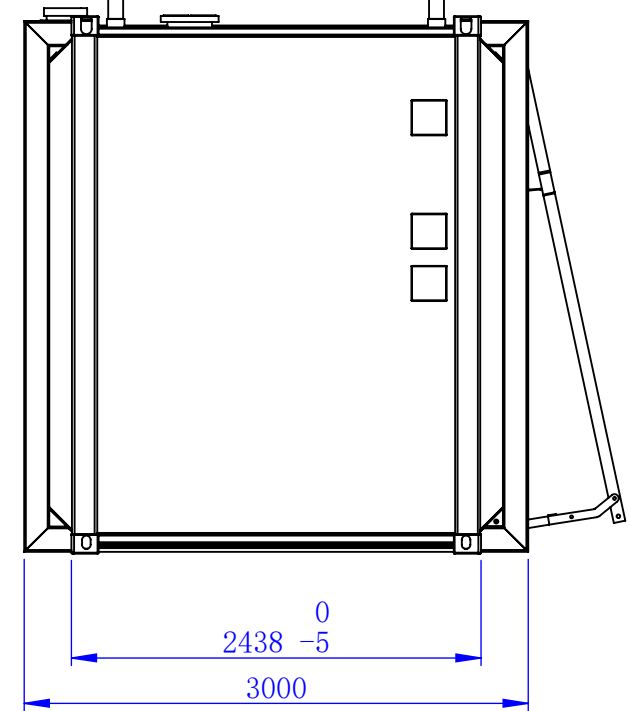
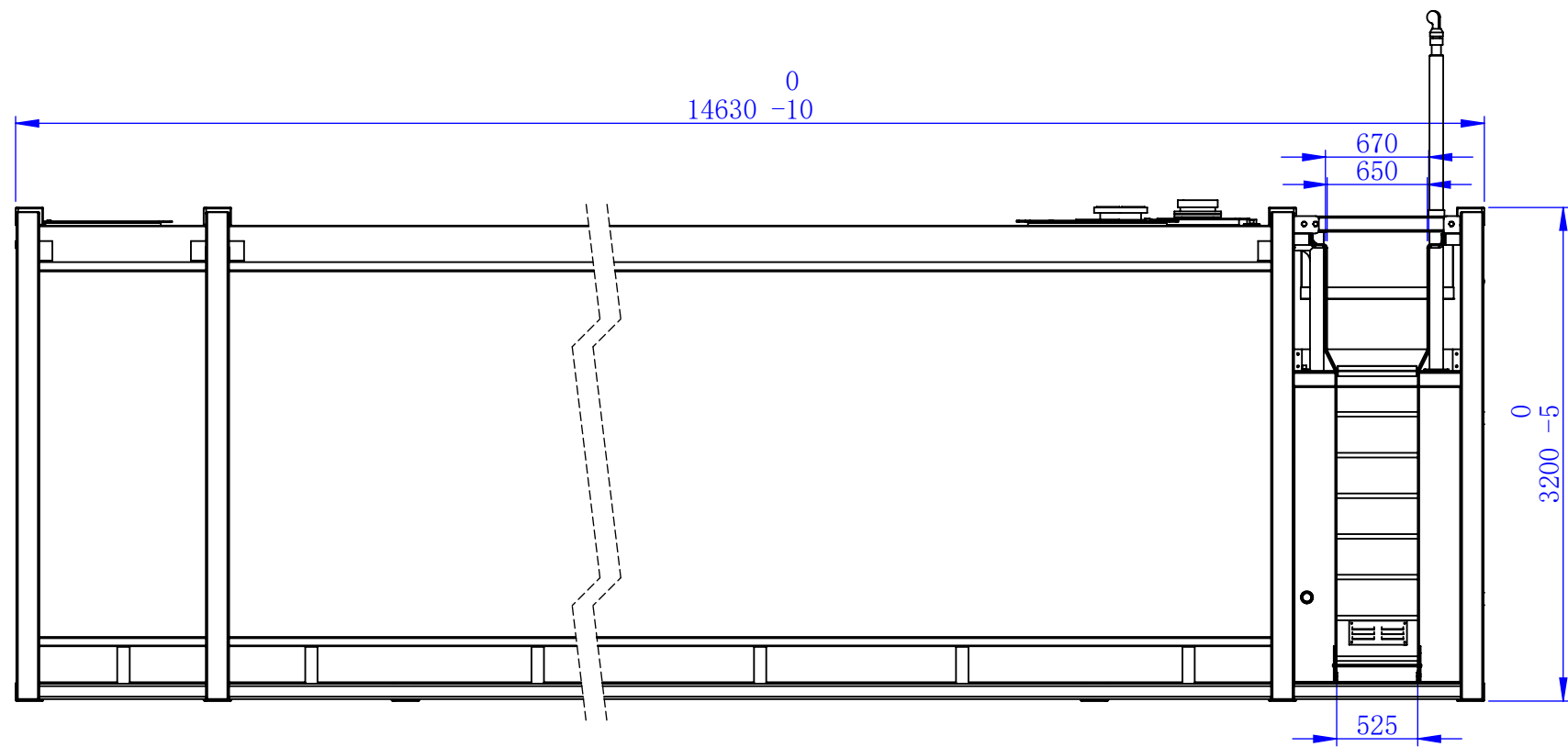

DRAWN:	SAVING DATE:	TITLE:		
	2020/4/10	48' HC	CON-110 Self Bunded Tank	
CHECKED:	DATE:	DRAWING NO. :	REV:	A3
CLIENT:	DATE:		SHEET:	
			1 of 13	
APPROVED:	DATE:	PURCHASE ORDER NO. :	Scale:	⊕ - ▷
Weight:	19148. 83KG		No scale	



						Project :	
						CON-110 Self Bunded Tank	
						Part Name:	
						48' HC	
						Part NO. :	
NO.	Changes	File	SIGN	DATE	Material		
Design		2020/4/10			Weight	19148.83KG	
CHK' D						Revision	01
CHK' D						SHEET 2	TOTAL SHEET 13
APPV' D							

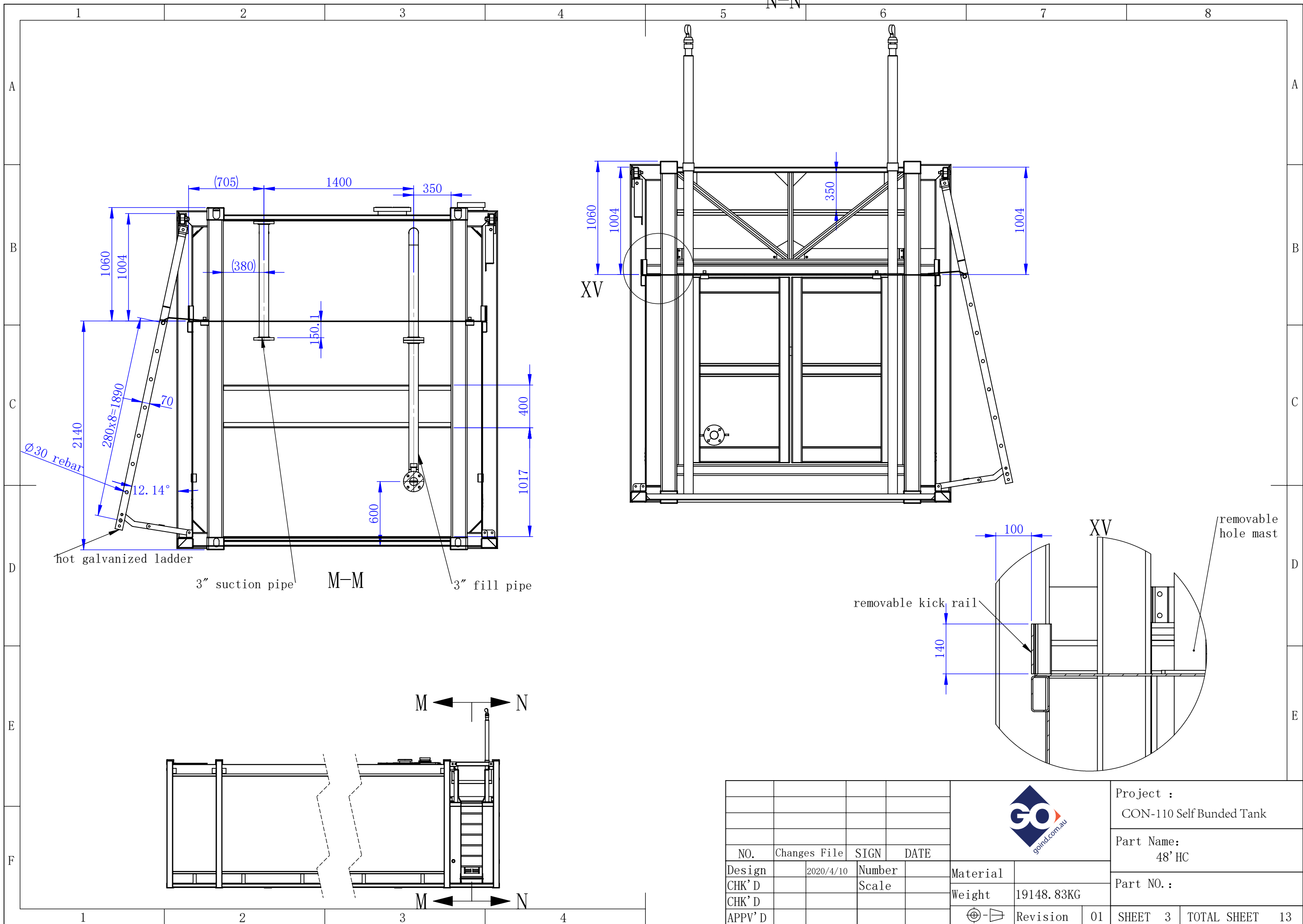

						Project :	
						CON-110 Self Bunded Tank	
						Part Name:	
						48' HC	
						Part NO. :	
NO.	Changes	File	SIGN	DATE	Material		
Design		2020/4/10			Weight	19148.83KG	
CHK' D					Revision	01	
CHK' D							SHEET 3
APPV' D							TOTAL SHEET 13